

brilliance in solar lighting

photinus

DATA SHEET V1 | 2019

protos200 | protos200 duo

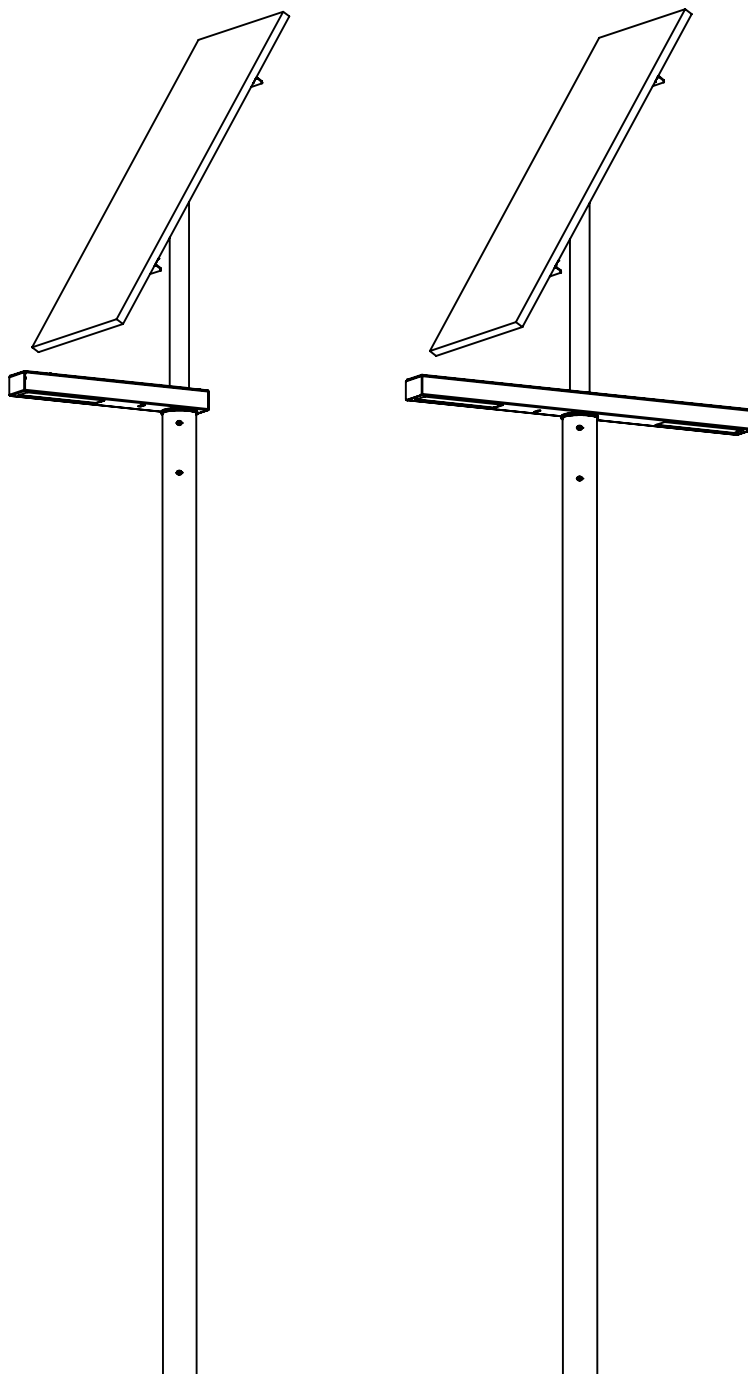

1

protos 200

SELF-SUFFICIENT SOLAR LED STREET LAMP

USAGE

It is „functional with appealing design“ and it is called protos. It is a self-sustaining, exterior solar LED lamp with various technical options. The energy supply is based on an efficient mono-crystalline photovoltaic module, the inclination of which can be adjusted. Intelligent controls with independent day- and night-time recognition enables different time programs. Given the short assembling and disassembling times, protos is excellently suitable as street lighting or for temporary usage wherever cordless lighting is required, such as construction sites, parking lots, access roads, outdoor events or company premises.

The high-efficiency LEDs and advanced optical components ensure impressive light distribution. protos meets the country-specific light-technical requirements of DIN 13201 for residential streets with low traffic, cycle paths and footpaths, parking lots and company premises.

FUNCTION

The integrated battery is charged during daytime by the efficient photovoltaic solar module. At nightfall, the LED light module is automatically activated.

The light output of a solar lamp is defined by the incident solar irradiation at the respective location, which is why the quality of the individual components and their optimum interaction play a decisive role.

The LiFePo4 battery used in protos is shored in the ground together with the post so that an optimum, constant temperature is achieved. The long service life of the battery and efficient theft protection are the results.

2

TECHNICAL DATA

SOLAR MODULE

Solarmodule	mono- or poly-cristalline silicon cells
Module performance	200 W
Module dimensions	1320 mm x 992 mm x 35 mm
Open Circuit Voltage (VOC)	29.0V
Short Circuit Current (ISC)	9.08A
Maximum Power Voltage (Vmp)	23.9V
Maximum Power Current (Imp)	8.37A

BATTERY IN THE POLE

Battery	LiFePO4 / 461Wh (12.8V 36Ah) or LiFePO4 / 845Wh (12.8V 66Ah) (depending on location/latitude)
Operating temperature	-20°C to +60°C
Battery life	up to 10 years
Protection class	IPX8

LIGHTS

Max. luminous flux	Depending on the location where the light is staying. <u>Location: Luminous flux / autonomy time normal mode / smart mode</u> 52. degrees lat. (Amsterdam): 16 W, 2760 lm / V5 / 8 days / 12 days 47. degrees lat. (Munich): 18 W, 2800 lm / V5 / 6 days / 9 days 40. degrees lat. (Madrid): 44 W, 7580 lm / V5 / 3 days / 5 days
Efficiency	172/600mAh
LED module / max. watts	100 W
Colour temperature	4000 K
Life of LED	> 100 000 h
Protection class	IP67

OPTICS

photinus OPTIC

Standard optic with optimum compromise between illumination width and illumination depth

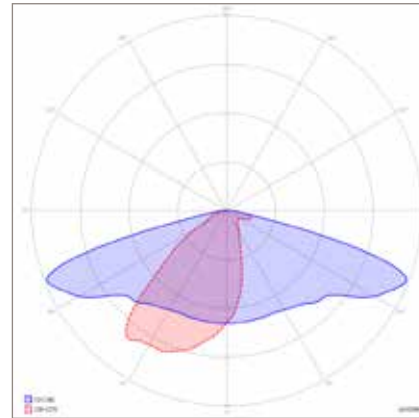
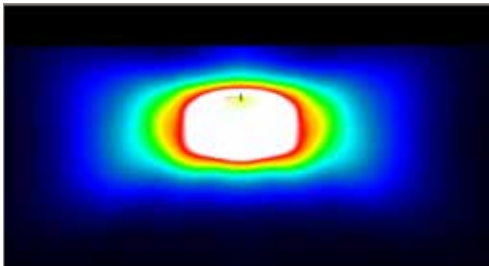

SCL OPTIC

optimal for streets with a width from 2m to 4m (cycle paths, walkways and small streets)

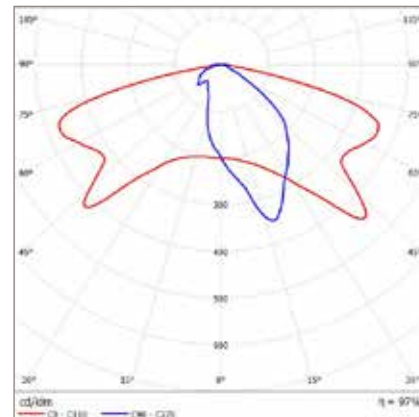
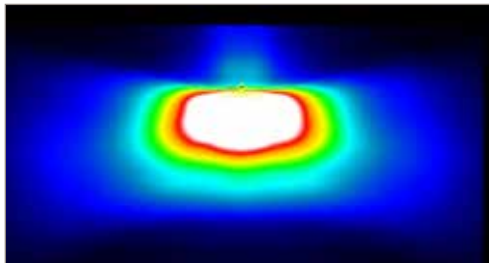

DWC OPTIC

optimal for streets with a width from 4m to 7m (Residential roads, secondary roads and main roads, depending on location)

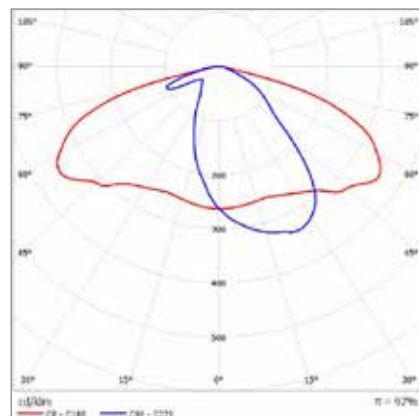
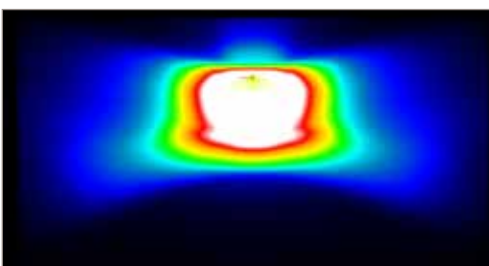

ENERGY AND TIME MANAGEMENT

Standard factory setting V5

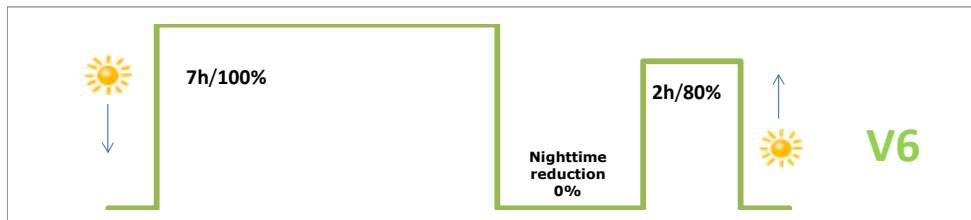
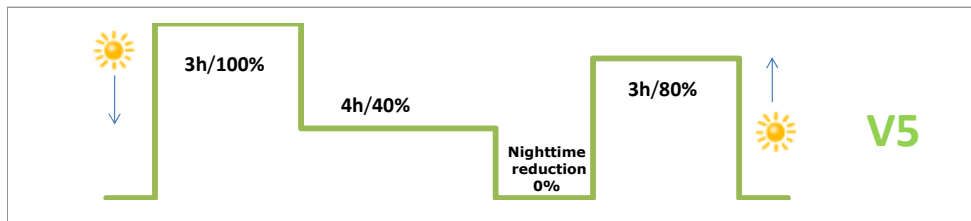
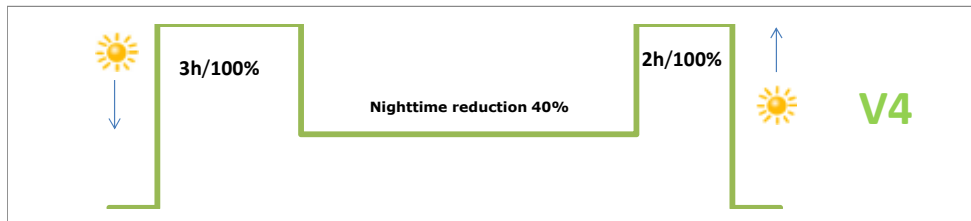
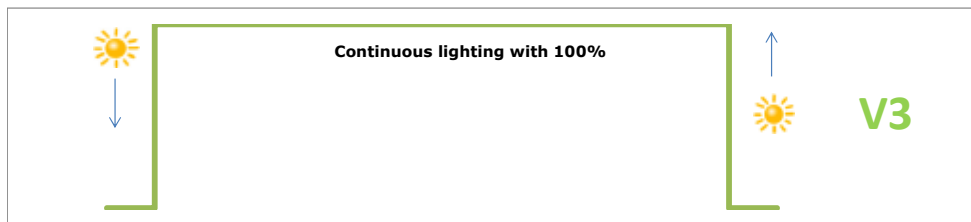

DIMENSIONS

Total height from ground level	depending on the position of the solar module approximately 6396 mm at 62°
Height of light from ground level	5005 mm
Total length of the pole	6396 mm
Weight	70 kg
Lenght of the pole in the ground	1000 mm
Material pole	galvanized and powder-coated steel „Sparkling iron effect dark“
Solar module dimensions	1320 mm x 992 mm x 35 mm
Weight	15.7 kg
Light housing dimensions	834 mm x 125 mm x 80 mm
Weight	2kg
Wind load	up to 90km/h

(technical changes reserved)

DIMENSIONS PROTOS200 / DUO

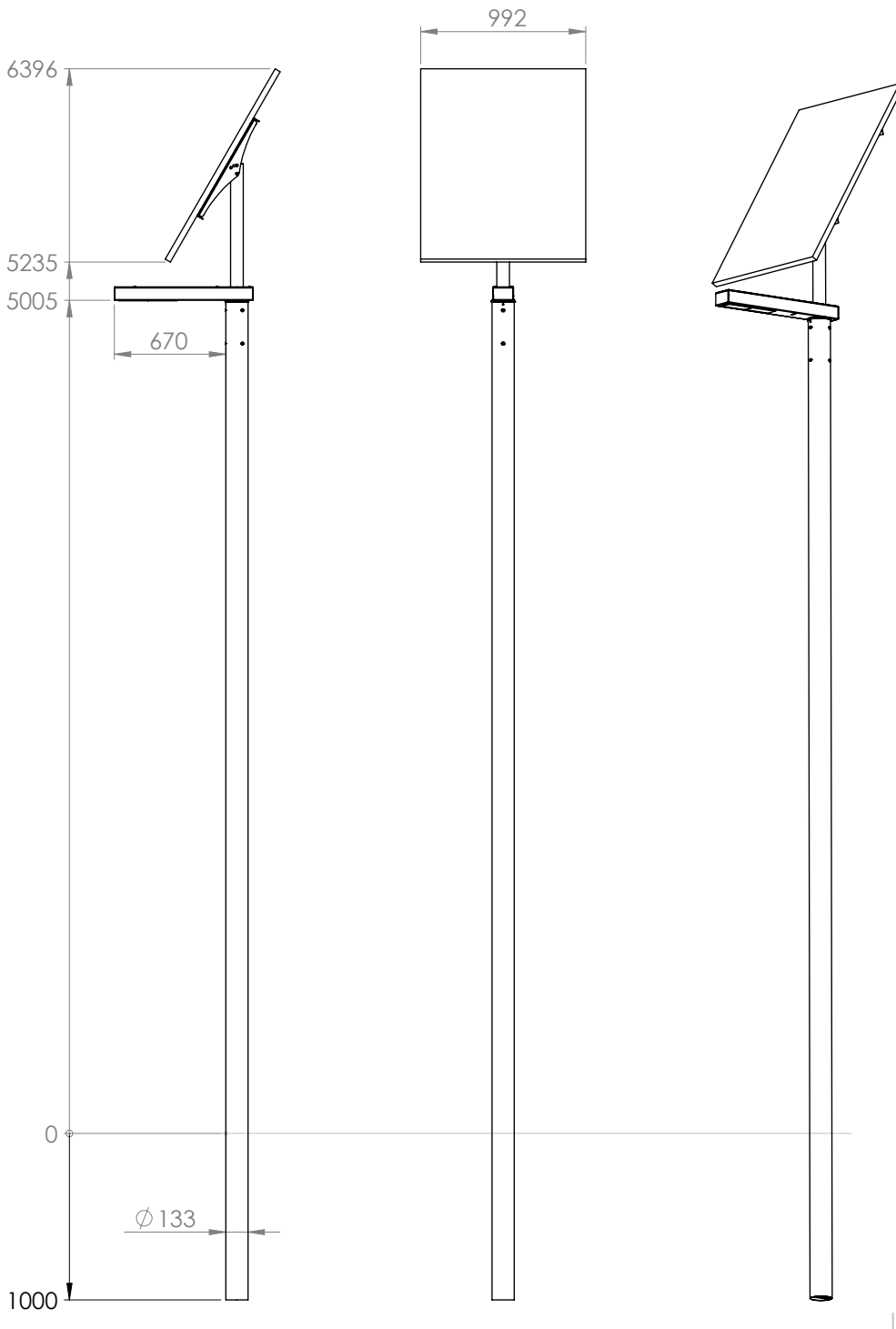

3

OPTIONS FOR ASSEMBLY

OPTION 1 - PIPE FOUNDATION

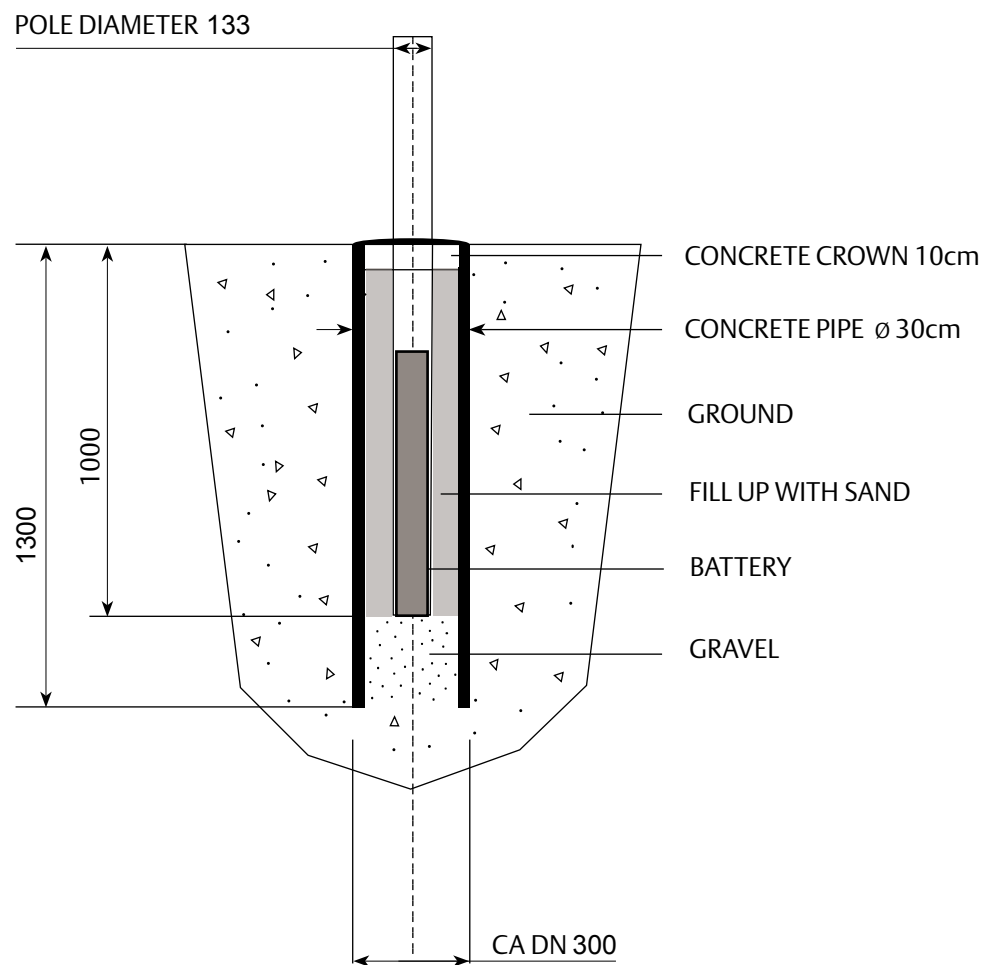

OPTION 2 - KRINNER GROUND SCREW

KRINNER Ground Screw

Art. 25513: KSF E194x2100-RG140-SMU151

